

**PIPER**



**CHEROKEE ARROW  
OWNER'S HANDBOOK**

**WARNING**

The rudder pedals are suspended from a torque tube which extends across the fuselage. The pilot should become familiar with the proper positioning of his feet on the rudder pedals so as to avoid interference with the torque tube when moving the rudder pedals or operating the toe brakes.

757 439

# CHEROKEE ' ARROW '

## Owner's Handbook



Piper Aircraft Corporation, Vero Beach, Florida  
U.S. A.

Assurance that the airplane is in an airworthy condition is the responsibility of the owner. The pilot in command is responsible for determining that the airplane is safe for flight. The pilot is also responsible for remaining within the operating limitations outlined by the Flight Manual, instrument markings, and placards.

If an inconsistency of information exists between this handbook and the Flight Manual approved by the FAA, the Flight Manual shall be the authority.

Additional copies of this manual, Part No. 753 750, may be obtained from your Piper Dealer.

Published by  
PUBLICATIONS DEPARTMENT  
Piper Aircraft Corporation  
753 750  
Issued: July 1967  
Revised: August 1969



**SECTION I**  
**SPECIFICATIONS**

Performance . . . . .	1
Weights . . . . .	2
Power Plant . . . . .	2
Fuel and Oil . . . . .	2
Baggage . . . . .	2
Dimensions . . . . .	3
Landing Gear . . . . .	3

SECTION I

SPECIFICATIONS

PERFORMANCE

Performance figures are for airplane equipped for cross-country transportation and flown at gross weight under standard conditions at sea level or stated altitude. Any changes in equipment may result in changes in performance.

Take-off Run (maximum effort, 25° flap) (ft)	820
Take-off over 50-ft barrier (maximum effort, 25° flap) (ft)	1665
Best Rate of Climb Speed (mph)	100
Rate of Climb (ft per min)	875
Service Ceiling (ft)	15,000
Absolute Ceiling (ft)	17,000
Top Speed (mph)	170
Optimum Cruising Speed (75% power, optimum altitude) (mph)	162
Cruising Range (75% power, optimum altitude) (mi)	857
Optimum Cruising Range (55% power, optimum altitude) (mi)	995
Stalling Speed (flaps down, gear down) (mph)	63
Stalling Speed (flaps and gear up) (mph)	69
Landing Roll (flaps down) (ft)	776
Landing Roll over 50-ft barrier (ft)	1340

## SECTION I

## CHEROKEE "ARROW"

## SPECIFICATIONS (cont):

## WEIGHTS

Gross Weight (lbs)	2500
Empty Weight (Standard) (lbs)	1380
USEFUL LOAD (Standard) (lbs)	1120

## POWER PLANT

Engine (Lycoming)	IO-360-B1E
Rated Horsepower	180
Rated Speed (rpm)	2700
Bore (in.)	5.125
Stroke (in.)	4.375
Displacement (cu in.)	361.0
Compression Ratio	8.5:1
Dry Weight (lbs)	291
Propeller	HC-C2YK-1/7666A-0

## FUEL AND OIL

Fuel Capacity (U.S. gal)	50
Oil Capacity (qts)	8
Fuel, Aviation Grade (min octane)	100/130

## BAGGAGE

Maximum Baggage (lbs)	200
Baggage Space (cu ft)	17
Baggage Door Size (in.)	20 x 22

## CHEROKEE "ARROW"

## SECTION I

## SPECIFICATIONS (cont):

## DIMENSIONS

Wing Span (ft)	30
Wing Area (sq ft)	160
Wing Loading (lbs per sq ft)	15.6
Length (ft)	24.2
Height (ft)	8.0
Power Loading (lbs per hp)	13.9

## LANDING GEAR

Wheel Base (ft)	7.4
Wheel Tread (ft)	10.5
Tire Pressure (psi)	30
Tire Size	27
	Main
	Nose (4 ply rating)
	Main (4 ply rating)
	5.00 x 5
	6.00 x 6

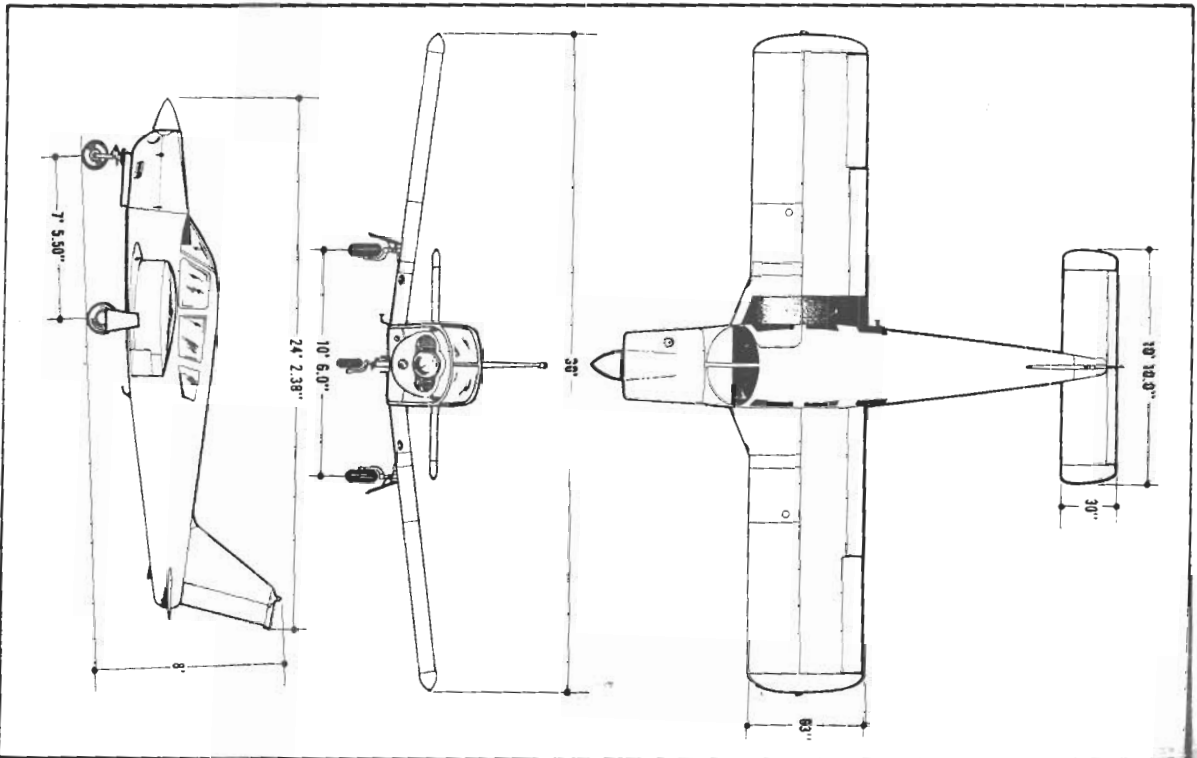

SECTION II

DESIGN INFORMATION

Engine and Propeller . . . . . 5

Induction System . . . . . 5

Structures . . . . . 6

Landing Gear . . . . . 7

Control Systems . . . . . 11

Fuel System . . . . . 11

Electrical System . . . . . 12

Heating and Ventilating System . . . . . 16

Cabin Features . . . . . 16

## SECTION II

## DESIGN INFORMATION

## ENGINE AND PROPELLER

The Cherokee Arrow is powered by a Lycoming IO-360-B1E four cylinder, direct drive, horizontally opposed, fuel injected engine rated at 180 H.P. It is furnished with starter, 60 ampere 12 volt alternator, shielded ignition, vacuum pump drive, fuel pump, and a dry automotive type injector air filter.

The exhaust system is of the cross-over type to reduce back pressure and improve performance. It is made entirely from stainless steel and is equipped with dual mufflers. A heater shroud around the mufflers is provided to supply heat for the cabin and windshield defrosting.

The propeller used is a Hartzell HC-C2YK-1/7666A-0. It is a constant speed controllable pitch unit with the control located on the control quadrant between the throttle and mixture controls.

## INDUCTION SYSTEM

The Bendix RSA-5AD1 type fuel injection system installed in the Cherokee Arrow is based on the principle of measuring airflow and using the airflow signals to operate a servo valve. The accurately regulated fuel pressure established by the servo valve, when applied across a fuel control (jetting system), makes fuel flow proportional to airflow.

Fuel pressure regulation by the servo valve causes a minimal drop in fuel pressure throughout the metering system. Metering



pressure is maintained above most vapor-forming conditions while fuel inlet pressure is low enough to allow use of a diaphragm pump. The servo system feature also checks vapor lock and associated starting problems.

The servo regulator meters fuel flow proportionally with air-flow and maintains the mixtures as manually set for all engine speeds. The fuel flow divider receives metered fuel and distributes fuel to each cylinder fuel nozzle.

The fuel flow portion of the manifold pressure fuel flow gauge is connected to the flow divider and monitors fuel pressure. This instrument converts fuel pressure to an indication of fuel flow in gallons per hour and percentage of rated horsepower.

The alternate air source of the induction system contains a door that functions automatically and/or manually. If the primary source is obstructed, the door will open automatically. It may be opened manually by moving the selector on the right side of the quadrant. The primary source should always be used for take-off.

## STRUCTURES

All structures are of aluminum alloy construction and are designed to ultimate load factors well in excess of normal requirements. All exterior surfaces are primed with etching primer and painted with acrylic lacquer.

The wings are attached to each side of the fuselage by inserting the butt ends of the respective main spars into a spar box carry-through, an integral part of the fuselage structure, thus providing in effect a continuous main spar which splices at each side of the fuselage. There are also fore and aft attachments at the rear spar and at an auxiliary front spar.

The wing airfoil section is a laminar flow type, NACA652-415 with the maximum thickness about 40% aft of the leading edge. This permits the main spar carry-through structure to be located under the rear seat providing unobstructed cabin floor space ahead of the rear seat.

## LANDING GEAR

The Cherokee Arrow is equipped with a retractable tricycle landing gear which is hydraulically actuated by an electrically powered reversible pump. The pump is controlled by a selector switch on the instrument panel to the left of the control quadrant. The landing gear is retracted or extended in about seven seconds.

Also incorporated in the system is a pressure sensing device which lowers the gear regardless of gear selector position, depending upon airspeed and engine power (propeller slipstream). Gear extension is designed to occur, even if the selector is in the up position, at airspeeds below approximately 105 MPH with power off. The device also prevents the gear from retracting at airspeeds below approximately 85 MPH with full power, though the selector switch may be in the up position. This speed increases with reduced power and/or increased altitude. The gear will not retract above a speed of approximately 125 to 130 MPH. The sensing device operation is controlled by differentially linked pressure across a flexible diaphragm which is mechanically linked to a hydraulic valve and an electrical switch which actuates the pump motor. A high pressure and static air source for actuating the diaphragm is provided in a mast mounted on the left side of the fuselage above the wing. Manual override of the device is provided by an emergency gear lever located between the front seats to the left of the flap handle.

The emergency gear lever, used for emergency extension of the gear, manually releases hydraulic pressure to permit the gear to free-fall with spring assistance on the nose gear. The lever must be held in the downward position for emergency extension. This same lever, when held in the

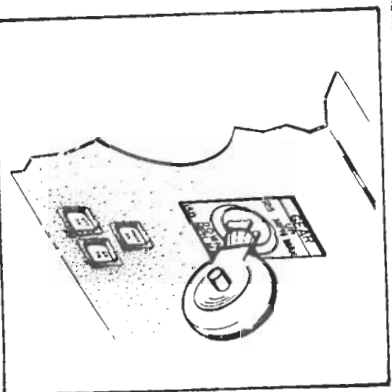

Landing Gear Selector

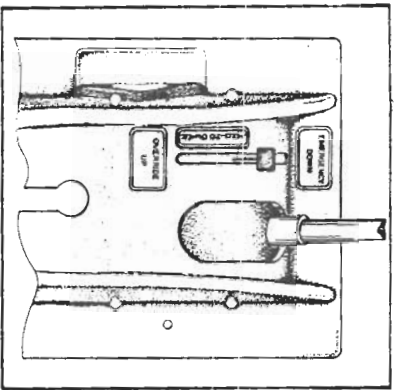
**Emergency Gear Lever**

positions is located at the top of the panel. All lights out indicate the gear is up.

Two micro-switches in the throttle quadrant activate a warning horn and a red "Warning Gear Up" light under the following conditions:

- (1) Gear up and power reduced below approximately 14 inches of manifold pressure.
- (2) Gear extended by back-up gear extender system but gear selector switch is "UP," except at full throttle.
- (3) Gear selector switch is "UP" while on the ground.

The nose gear is steerable through a 60 degree arc through use of the rudder pedals. As the nose gear retracts, the steering linkage disengages to reduce rudder pedal loads in flight. The nose wheel is equipped with a hydraulic shimmy dampener.

The oleo struts are of the air-oil type, with normal extension being 2.75 inches for the nose gear and 2.0 inches for the main gear under normal static load (empty weight of airplane plus full fuel and oil).

The standard brake system includes toe brakes on the left set of rudder pedals and a hand brake located below and near the center of the instrument panel. The toe brakes and the lever have their own brake cylinders, but they both use a common reservoir. The parking brake is incorporated in the lever brake and is

raised position, can be used to override the system, and gear position is controlled by the selector switch regardless of airspeed/power combinations. The lever must also be held in the raised position when gear up stalls are practiced.

Gear down and locked positions are indicated by three green lights located below the selector, and a yellow light for in transit.

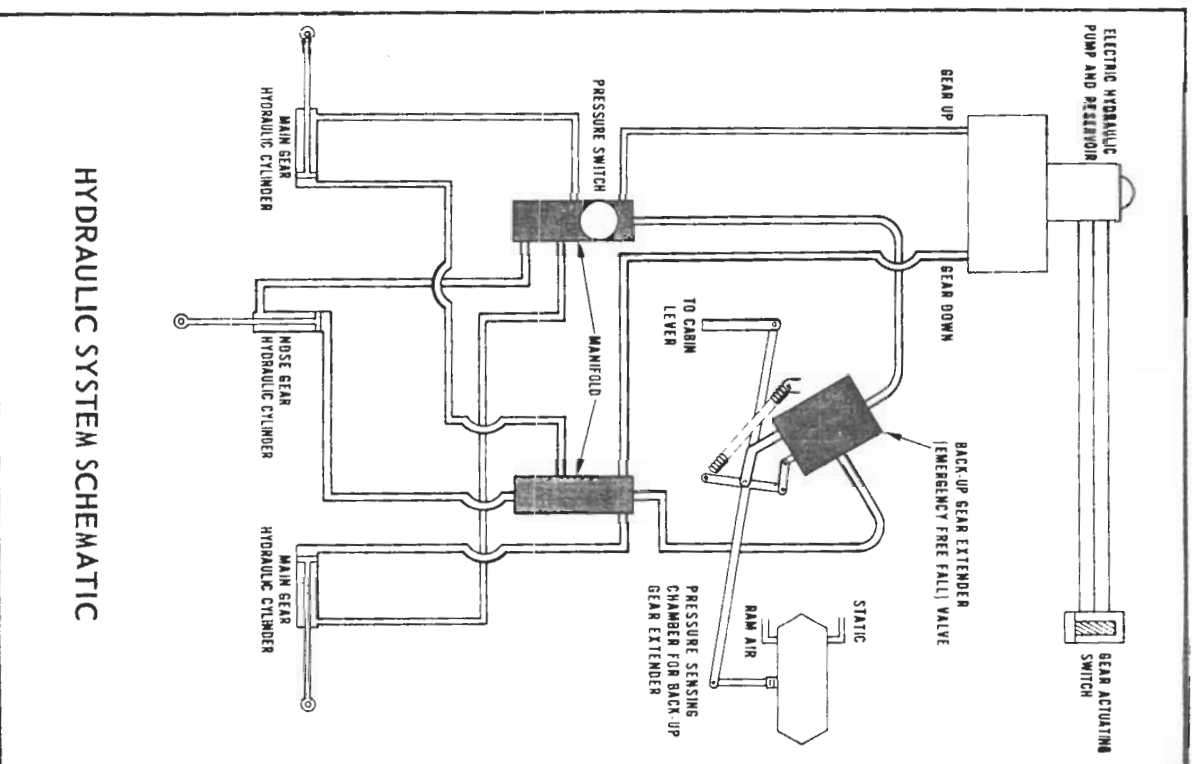
**HYDRAULIC SYSTEM SCHEMATIC**

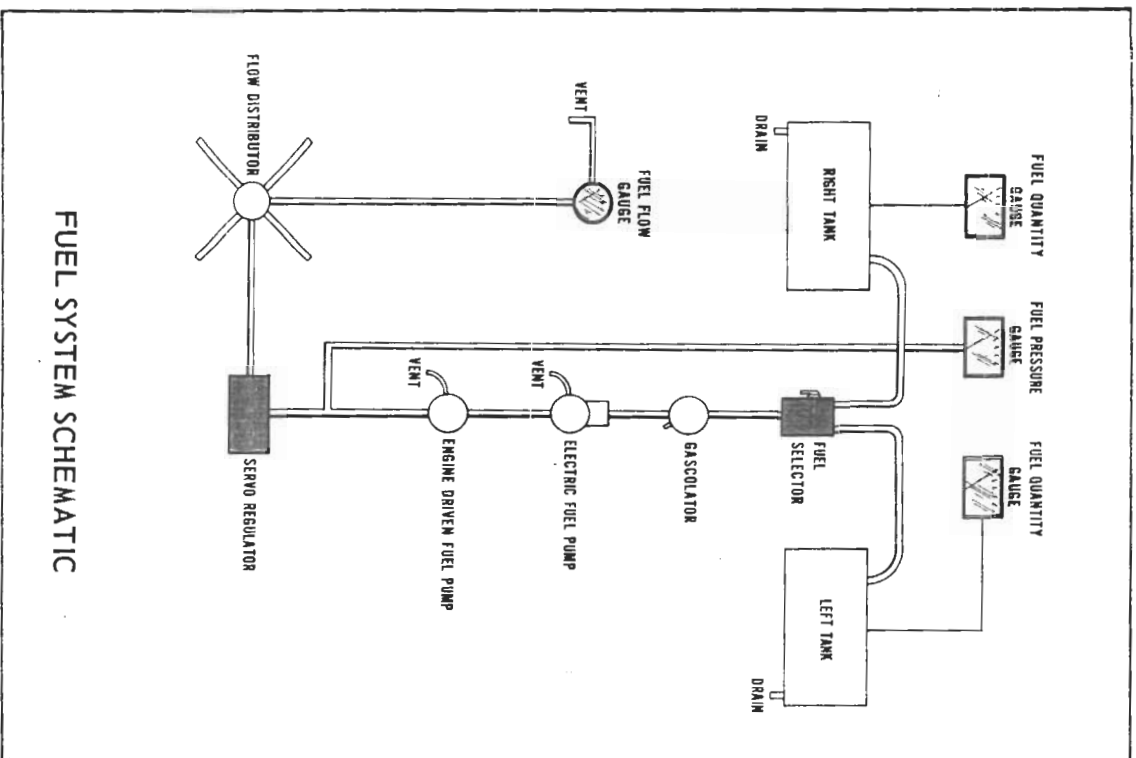

FUEL SYSTEM SCHEMATIC

operated by pulling back on the lever and depressing the knob attached to the top of the handle. To release the parking brake, pull back on the brake lever to disengage the catch mechanism; then allow the handle to swing forward.

### CONTROL SYSTEMS

Dual controls are provided as standard equipment with a cable system used between the controls and the surfaces. The horizontal tail is of the Flying Tail type (stabilator), with a trim tab mounted on the trailing edge of the stabilator to reduce the control system forces. This tab is actuated by a control wheel on the floor between the front seats. The stabilator provides extra stability and controllability with less size, drag and weight than conventional tail surfaces. The ailerons are provided with a differential action which tends to reduce adverse yaw in turning maneuvers, and which also reduces the amount of coordination required in normal turns. A rudder trim adjustment is mounted on the right side of the pedestal below the throttle quadrant and permits directional trim as needed in flight.

The flaps are manually operated, balanced for light operating forces and spring loaded to return to the up position. A past-center lock incorporated in the actuating linkage holds the flap when it is in the up position so that it may be used as a step on the right side. The flap will not support a step load except when in the full up position, so it must be completely retracted when used as a step. The flaps have three extended positions: 10, 25 and 40 degrees.

### FUEL SYSTEM

Fuel is stored in two twenty-five gallon tanks which are secured to the leading edge structure of each wing by screws and

nut plates. This allows easy removal for service or inspection.

An auxiliary electric fuel pump is provided in case of failure of the engine driven pump. The electric pump should be on for all take-offs and landings, and when switching tanks. The pump switch is located in the switch panel above the throttle quadrant.

Each tank has an individual quick drain located at the bottom, inboard, rear corner, and should be drained to check for water before each flight. The fuel strainer, which is also equipped with a quick drain, is located on the front lower left corner of the firewall. This strainer should be drained regularly to check for water or sediment accumulation.

Fuel quantity and pressure are indicated on gauges located in a cluster on the left side of the instrument panel.

### ELECTRICAL SYSTEM

The electrical system includes a 12 volt 60 amp alternator, battery, voltage regulator, overvoltage relay and master switch relay. The battery is mounted in a stainless steel box immediately aft of the baggage compartment. The regulator and overvoltage relay are located on the forward left side of the fuselage

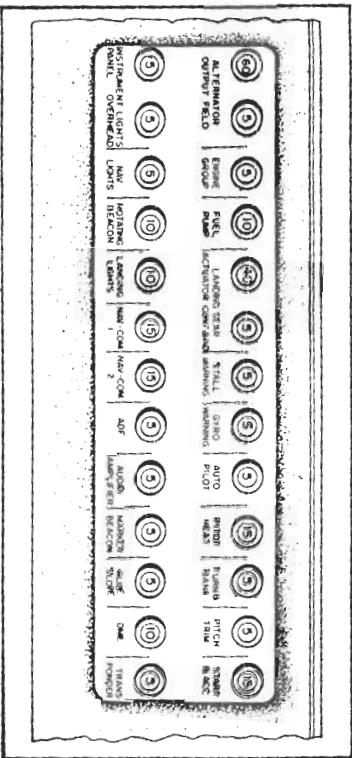

Circuit Breaker Panel



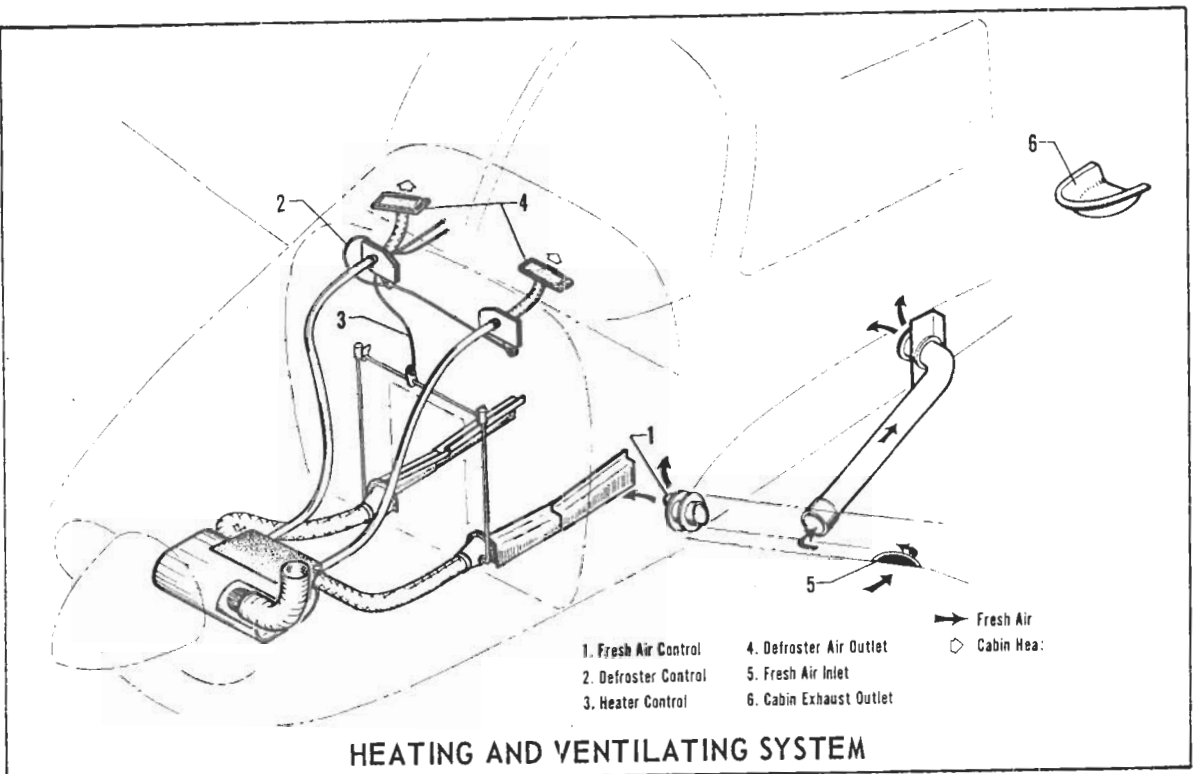

behind the instrument panel.

Electrical switches are located on the right center instrument panel, and the circuit breakers are located on the lower right instrument panel. A rheostat-switch on the left side of the switch panel controls the navigation lights and the dome instrument light. It also dims the dome light. The similar switch on the right side controls and dims the panel lights.

Standard electrical accessories include starter, electric fuel pump, stall warning indicator, cigar lighter, voltmeter, and ammeter.

Navigation lights, anti-collision light, landing light, instrument lighting and cabin dome light are offered as optional accessories.

Circuit provisions are made to handle a complete complement of communications and navigational equipment.

The alternator system offers many advantages over the generator system both in operation and maintenance. The main advantage is, of course, full electrical power output at much lower engine RPM. This is a great improvement for radio and electrical equipment operation. Also, because of the availability of alternator output at all times, the battery will be charging for a greater percentage of use, which will make cold-morning starting easier.

Unlike previous generator systems, the ammeter does not indicate battery discharge; rather it displays in amperes the load placed on the system. With all electrical equipment off (except master switch) the ammeter will be indicating the amount of charging current demanded by the battery. This amount will vary, depending on the percentage of full charge in the battery at the time. As the battery becomes charged, the amount of current displayed on the ammeter will reduce to about two amperes. When each piece of electrical equipment is switched on, the current will add up and the total, including the battery, will appear on the ammeter. The maximum continuous load for night flight, with radios on, is about 30 amperes. This 30 ampere value, plus approximately two amperes for a fully charged battery, will appear continuously under these flight conditions. The amount of current

**SECTION II**

**CHEROKEE "ARROW"**

Shown on the ammeter will tell immediately whether the alternator system is operating normally, as the amount of current shown should equal the total amount of amperes being drawn by the equipment which is operating.

If no output is indicated on the ammeter during flight, reduce the electrical load by turning off all unnecessary electrical equipment. Check both 5 ampere field breaker and 60 ampere output breaker and reset if open. If neither circuit breaker is open, turn off the master switch for 30 seconds to reset the overvoltage relay. If ammeter continues to indicate no output, maintain minimum electrical load and terminate flight as soon as practical. Maintenance on the alternator should prove to be a minor factor. Should service be required, contact the local Piper Dealer.

**HEATING AND VENTILATING SYSTEM**

Heat for the cabin interior and the defroster system is provided by a heater muff attached to the exhaust system. The amount of heat desired can be regulated with the controls located on the far right side of the instrument panel.

Fresh air inlets are located in the leading edge of the wing at the intersection of the tapered and straight sections. A large adjustable outlet is located on the side of the cabin near the floor at each seat location. Cabin air is exhausted through an outlet located below the rear seat.

**CABIN FEATURES**

The instrument panel of the Cherokee Arrow is designed to accommodate the customary advanced flight instruments and all the normally required power plant instruments. The Artificial Horizon and Directional Gyro are vacuum operated through use of a vacuum pump installed on the engine, while the Turn and

**CHEROKEE "ARRO**

**SECTION II**

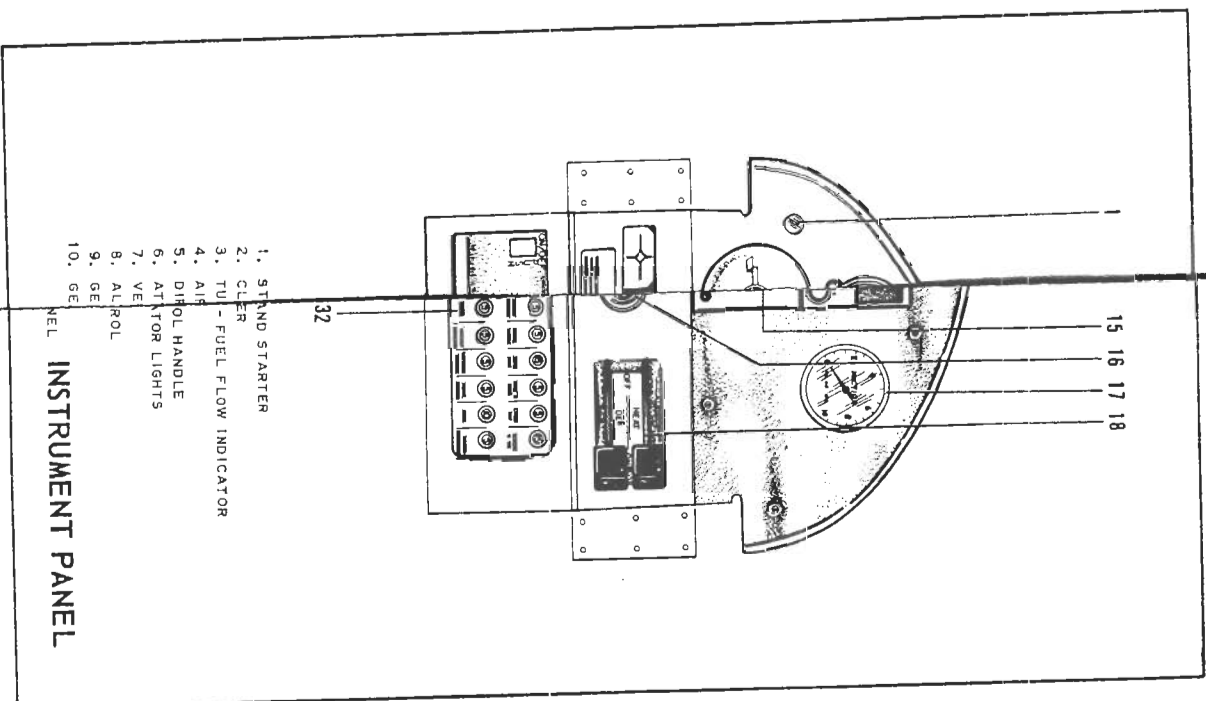

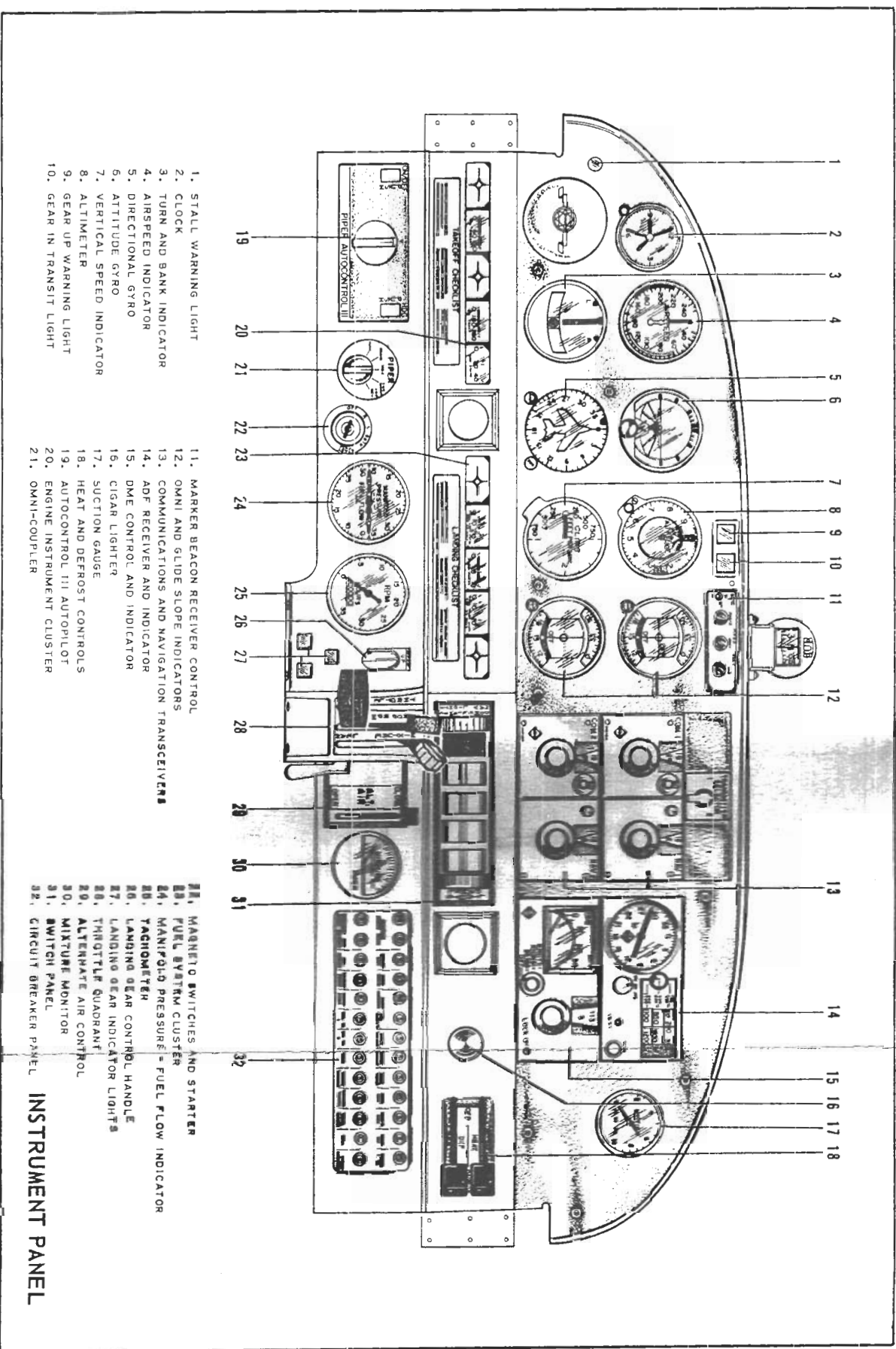

- 1. STALL WARNING LIGHT
- 2. CLOCK
- 3. TURN AND BANK INDICATOR
- 4. AIRSPEED INDICATOR
- 5. DIRECTIONAL GYRO
- 6. ATTITUDE GYRO
- 7. VERTICAL SPEED INDICATOR
- 8. ALTIMETER
- 9. GEAR UP WARNING LIGHT
- 10. GEAR IN TRANSIT LIGHT
- 11. MARKER BEACON RECEIVER CONTROL
- 12. OMNI AND GLIDE SLOPE INDICATORS
- 13. COMMUNICATIONS AND NAVIGATION TRANSCIEVERS
- 14. ADF RECEIVER AND INDICATOR
- 15. DME CONTROL AND INDICATOR
- 16. CIGAR LIGHTER
- 17. SUCTION GAUGE
- 18. HEAT AND DEFROST CONTROLS
- 19. AUTOCONTROL III AUTOPILOT
- 20. ENGINE INSTRUMENT CLUSTER
- 21. OMNI-COUPLER
- 22. MAGNETO SWITCHES AND STARTER
- 23. FUEL SYSTEM CLUSTER
- 24. MANIFOLD PRESSURE & FUEL FLOW INDICATOR
- 25. TACHOMETER
- 26. LANDING GEAR CONTROL HANDLE
- 27. LANDING GEAR INDICATOR LIGHTS
- 28. THROTTLE QUADRANT
- 29. ALTERNATE AIR CONTROL
- 30. MIXTURE MONITOR
- 31. SWITCH PANEL
- 32. CIRCUIT BREAKER PANEL

**INSTRUMENT PANEL**



Bank instrument is electrically operated. Above the Attitude Gyro are two lights which indicate high or low vacuum. A natural separation of the flight group and the power group is provided by placing the flight instruments in the upper panel and the power group in the center and lower sub-panels. The radios and circuit breakers are on the right hand instrument panel, and extra circuits are provided for a complete line of optional radio equipment.

The cabin interior includes a pilot storm window, two sun visors, ash trays, two map pockets, and pockets on the backs of each front seat. The front seats are adjustable fore and aft for pilot-passenger comfort and ease of entry and exit. Recessed arm rests are also provided for the front seats.

The 17 cubic foot baggage area may be reached from the cabin or through a large 20 x 22 inch outside door.

SECTION III  
OPERATING INSTRUCTIONS

Preflight . . . . .	20
Starting Engine . . . . .	21
Warm-Up and Ground Check . . . . .	23
Take-Off . . . . .	24
Climb . . . . .	25
Stalls . . . . .	25
Cruising . . . . .	26
Approach and Landing . . . . .	27
Stopping Engine . . . . .	28
Emergency Gear Procedures . . . . .	29
Engine Power Loss . . . . .	30
Moorings . . . . .	30
Weight and Balance . . . . .	31
Operating Tips . . . . .	31

SECTION III

OPERATING INSTRUCTIONS

PREFLIGHT

The airplane should be given a thorough visual inspection prior to each flight. Particular attention should be given to the following items:

1. Master switch and ignition OFF, landing gear switch DOWN.
2. a. Check for external damage and operational interference of control surfaces or hinges.

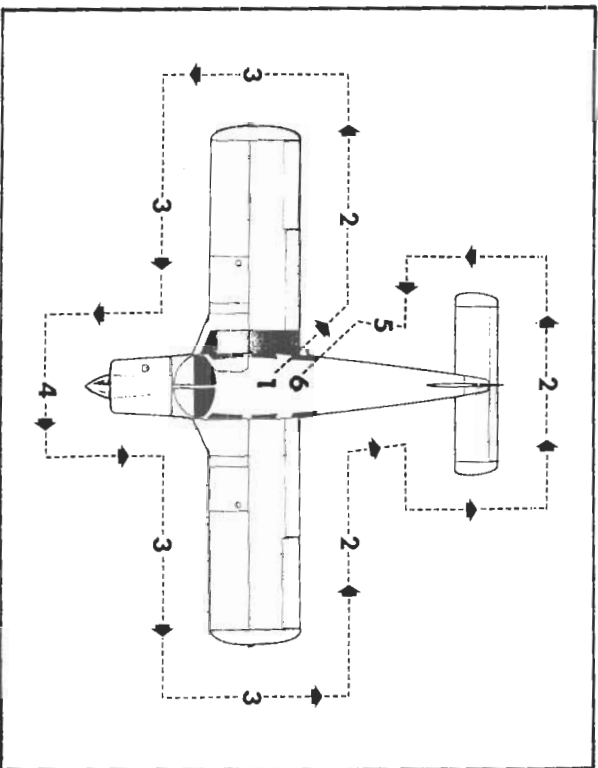

- b. Insure that wings and control surfaces are free of snow, ice or frost.
3. a. Visually check fuel supply, secure caps.
- b. Drain fuel tank sumps (two).
- c. Drain fuel system sump (left side of aircraft).
- d. Check that fuel system vents are open.
- e. Check landing gear shock struts for proper inflation (approximately 2 inches showing).
- f. Check hydraulic lines and landing gear cylinders for excessive leaks.
- g. Check tires for cuts, wear and proper inflation.
4. a. Check windshield for cleanliness.
- b. Check propeller and spinner for defects or nicks.
- c. Check for obvious fuel or oil leaks.
- d. Check oil level (insure dipstick is properly seated).
- e. Check cowling and inspection covers for security.
- f. Check nose wheel tire for inflation or wear.
- g. Check nose gear shock strut for proper inflation (approximately 2-3/4 inches showing).
- h. Check hydraulic lines and landing gear cylinder for excessive leaks.
- i. Check for foreign matter in air inlet.
5. a. Stow tow bar and control locks if used.
- b. Check baggage for proper storage and security.
- c. Close and secure the baggage compartment door.
6. a. Upon entering airplane, check that all primary flight controls operate properly.
- b. Close and secure cabin door.
- c. Check that required papers are in order and in the airplane.

### STARTING ENGINE

After completion of the preflight inspection:

1. Set brakes ON.

2. Set the propeller control in full INCREASE RPM (control forward).
3. Select the desired tank with fuel selector valve.

#### Starting Engine When Cold:

1. Open the throttle approximately 1/2 inch.
2. Turn the master switch ON.
3. Turn the electric fuel pump ON.
4. Move the mixture control to FULL RICH until an indication on the fuel flow meter is noted. (Engine is primed.)
5. Move the mixture control to IDLE CUT-OFF.
6. Engage the starter by rotating magneto switch clockwise and pressing in.
7. When the engine fires, advance mixture control to FULL RICH and move throttle to the desired setting. If the engine does not fire within five to ten seconds, disengage starter and reprime.

#### Starting Engine When Hot:

1. Open the throttle approximately 1/2 inch.
2. Turn the master switch ON.
3. Turn the electric fuel pump ON.
4. Put mixture control in IDLE CUT-OFF.
5. Engage the starter by rotating magneto switch clockwise and pressing in. When the engine fires, advance the mixture control and move the throttle to desired setting.

#### Starting Engine When Flooded:

1. Open the throttle full.
2. Turn the master switch ON.
3. Turn the electric fuel pump OFF.
4. Put mixture control in IDLE CUT-OFF.
5. Engage the starter by rotating the magneto switch clockwise and pressing in. When the engine fires, advance the mixture control and retard the throttle.

When the engine is firing evenly, advance the throttle to 800 RPM. If oil pressure is not indicated within thirty seconds,

stop the engine and determine the trouble. In cold weather it will take a few seconds longer to get an oil pressure indication. If the engine has failed to start, refer to the "Upcoming Operating Handbook, Engine Troubles and Their Remedies."

Starter manufacturers recommend that cranking periods be limited to thirty seconds with a two minute rest between cranking periods. Longer cranking periods will shorten the life of the starter.

#### WARM-UP AND GROUND CHECK

Warm-up the engine at 1400 to 1500 RPM for not more than two minutes in warm weather, four minutes in cold weather. Avoid prolonged idling at low RPM as this practice may result in fouled spark plugs. If necessary to hold before take-off, it is recommended that engine be operated at 1400-1500 RPM.

The magnetos should be checked at 2300 RPM with the propeller set at increase RPM. Drop off on either magneto should not exceed 125 RPM and should have a differential of not more than 50 RPM. Prolonged operation on one magneto should be avoided.

Check both the oil temperature and pressure. The temperature may be low for some time if the engine is being run for the first time of the day, but as long as the pressure is within limits the engine is ready for take-off.

The propeller control should be moved through its complete range to check for proper operation and then placed to increase RPM for take-off. To obtain maximum RPM, push the pedestal-mounted control fully toward the instrument panel.

In cold weather the propeller control should be cycled at least three times to ensure that warm engine oil has circulated through the system.

The electric fuel pump should be turned off momentarily during ground check to make sure that the engine-driven pump is operating. The electric fuel pump should be on during take-off to prevent loss of power should the engine-driven pump fail. The

engine is warm enough for take-off when the throttle can be opened without the engine faltering. Do not take off with a dead battery as some voltage is needed to excite the alternator.

#### TAKE-OFF

Just before take-off the following items should be checked:

1. Fuel - on proper tank
2. Electric fuel pump - ON
3. Engine gauges - checked
4. Prop - set
5. Mixture - set
6. Quadrant friction knob - set
7. Flaps - set
8. Trim tab - set
9. Controls - free
10. Door - latched

The take-off technique is conventional for the Cherokee Arrow. The tab should be set slightly aft of neutral, with the exact setting determined by the loading of the aircraft. Allow the airplane to accelerate to 60 to 70 MPH, then ease back on the wheel enough to let the airplane fly itself off the ground. Premature raising of the nose, or raising it to an excessive angle will result in a delayed take-off. After take-off let the aircraft accelerate to the desired climb speed by lowering the nose slightly.

Take-offs are normally made with flaps up. However, for short field take-offs, and for take-offs under difficult conditions such as deep grass or on a soft surface, distances can be reduced appreciably by lowering flaps to 25° (second notch).

After take-off the pilot should retract the landing gear with the gear selector switch located on the instrument panel. If the gear selector switch is placed in the gear up position before reaching the airspeed\* at which the back-up gear extender system no longer commands gear down, the gear will not retract. This simply indicates that the system is functioning. Normally, the airplane should be allowed to accelerate to this airspeed\* before placing the selector switch in the gear up position.

For obstacle clearance on take-off and for take-off from high

altitude airports, the landing gear can be retracted at the pilot's discretion by placing the gear selector switch in the up position and then holding the emergency gear lever in the override up position. It is necessary to hold the lever in the override up position until the airspeed\* required for retraction by the back-up gear extender system has been attained.

After take-off has proceeded to a safe altitude, recommended climb power is 25 inches of manifold pressure and 2500 RPM.

\* Approximate airspeed of 85 MPH I.A.S. at sea level to 100 MPH I.A.S. at 10,000 ft, with a straight line variation between.

### CLIMB

The best rate of climb at gross weight will be obtained at 100 MPH. The best angle of climb may be obtained at 90 MPH. At lighter gross weights these speeds are reduced somewhat. For climbing en route a speed of 110 MPH is recommended. This will produce better forward speed and increased visibility over the nose during the climb.

### STALLS

All controls are effective at speeds down through the stalling speed, and stalls are gentle and easily controlled.

STALL SPEED TABLE

Angle of Bank	Flaps 40°	Flaps Retracted
0°	63 MPH	69 MPH
20°	65 MPH	71 MPH
40°	72 MPH	79 MPH
60°	89 MPH	98 MPH

Power Off — Gear Down — Gross Weight 2500 lbs.

### CRUISING

The cruising speed of the Cherokee Arrow is determined by many factors including power setting, altitude, temperature, loading, and equipment installed on the airplane.

The normal cruising power is 75% of the rated horsepower of the engine. True airspeeds which may be obtained at various altitudes and power settings can be determined from the charts in "Section IV" of this handbook.

When selecting RPM below 2400, limiting manifold pressure for continuous operation, as specified by the Lycoming Operator's Manual, should be observed.

To INCREASE power, first increase RPM, then increase manifold pressure.

To DECREASE power, first decrease manifold pressure, then decrease RPM.

Use of the mixture control in cruising flight reduces fuel consumption significantly, especially at higher altitudes. The mixture should be leaned during cruising operation above 5000 feet altitude and at the pilot's discretion at lower altitudes when 75% power or less is being used. If any doubt exists as to the amount of power being used, the mixture should be in the FULL RICH position for all operations under 5000 feet.

To lean the mixture, pull the mixture control until the engine becomes rough, indicating that the lean mixture limit has been reached in the leaner cylinders. Then enrich the mixture by pushing the control towards the instrument panel until engine operation becomes smooth. The fuel flow meter will give a close approximation of the fuel being consumed.

If the airplane is equipped with the optional exhaust gas temperature (EGT) gauge, a more accurate means of leaning is available to the pilot. For best power mixture, lean the mixture until the peak EGT is reached, then enrich the mixture until the temperature drops a minimum of 25° F. For best economy mixture, lean until the peak EGT is reached and continue to lean until the temperature drops a minimum of 25° F. Do not lean above 75% power.

In order to keep the airplane in best lateral trim during cruising flight, the fuel should be used alternately from each tank. It is recommended that one tank be used for one hour after take-off, then the other tank be used for two hours, then return to the first tank, which will have approximately one and one half hour of fuel remaining if the tanks were full plus reserve at take-off. The second tank will contain approximately one half hour of fuel. Do not run tanks completely dry in flight.

#### NOTE

There are no mechanical uplocks in the landing gear system. In the event of a hydraulic system malfunction, the landing gear will free fall to the gear down and locked position. The pilot should be aware that the airplane true airspeed with gear down is approximately 75% of the gear retracted airspeed for any given power setting. Allowances for the reduction in airspeed and range should be made when planning extended flight between remote airfields or flight over water.

### APPROACH AND LANDING

Before landing check list:

1. Fuel - on proper tank
2. Electric fuel pump - ON
3. Mixture - set
4. Prop - set
5. Gear - DOWN & LOCKED (150 MPH MAX)
6. Flaps - set (125 MPH MAX)

The airplane should be trimmed to an approach speed of about 90 MPH with the flaps and gear extended. The flaps can be lowered at speeds up to 125 MPH and the gear can be extended

at speeds up to 150 MPH if desired. The propeller should be set at approximately 2600 RPM to facilitate ample power for emergency go-around and will prevent over-speeding of the engine if the throttle is advanced sharply. The mixture control should be kept in full rich position to insure maximum acceleration if it should be necessary to open the throttle again.

The amount of flap used during landings and the speed of the aircraft at contact with the runway should be varied according to the landing surface and conditions of wind and airplane loading. It is generally good practice to contact the ground at minimum possible safe speed consistent with existing conditions.

Normally, the best technique for short and slow landings is to use full flaps and enough power to maintain the desired approach flight path. Mixture should be full rich, fuel on fullest tank, and electric fuel pump on. Reduce the airspeed during flare out and contact the ground close to stalling speed. After ground contact hold the nose wheel off as long as possible. As the airplane slows down, drop the nose and apply the brakes. There will be less chance of skidding the tires if the flaps are retracted before applying the brakes. Braking is most effective when back pressure is applied to the control wheel, putting most of the airplane weight on the main wheels. In high wind conditions, particularly in strong crosswinds, it may be desirable to approach the ground at higher than normal speeds with partial or no flaps.

### STOPPING ENGINE

At the pilot's discretion, the flaps should be raised and the electric fuel pump turned off. After parking, the radios should be turned off, the propeller set to increase RPM and the engine then stopped by pulling the mixture control to idle cut-off. The throttle should be left full aft to avoid engine vibration while stopping. Then the ignition and master switches should be turned off and the parking brake set.

**EMERGENCY GEAR PROCEDURES****Emergency Gear Extension:**

In the event that the gear selector switch is moved to the down position and the landing gear fails to lock down (gear is locked down when there are three green indicator lights), check the following items before initiating the emergency gear down procedure.

1. Master switch is on.
  2. Landing gear actuator control and indicator circuit breakers in.
  3. Panel lights are off (daytime) since gear indicator lights are dimmed with panel lights on.
  4. Bulbs in indicator lights have been changed.
- If gear down and locked indication is still not present, initiate the following procedures:

1. Reduce airspeed below 100 MPH.
2. Landing gear selector in gear down position.
3. If gear has failed to lock down, raise emergency gear lever to "override up" position.
4. Move emergency gear lever to the "emergency down" position while "fish-tailing" the airplane.
5. If gear still fails to lock down, move emergency gear lever to the override up position and hold in this position while "fish-tailing" the airplane until the gear is locked down as indicated by three green indicator lights.

**Gear Up Landing:**

During an emergency, a gear up landing may be made:

1. When the surface is too soft or rough to permit a satisfactory gear down landing.
  2. When a field is too short for a gear down landing, which might cause more damage through hitting obstructions than the gear up landing would cause.
  3. When a water landing is necessary.
- If a gear up landing is required, make an initial approach at not less than 110 MPH to prevent the gear from free falling:
1. Leave flaps up (to reduce wing and flap damage).

2. Close throttle and cut the master and ignition switch.
3. Turn the fuel selector switch off.
4. Hold the emergency gear lever in the override up position while reducing speed and until the airplane is firmly on the ground. Contact the ground at minimum airspeed.

**NOTE**

With the master switch off, the emergency gear lever must be held in the override up position continuously as airspeed is reduced, or the gear will extend.

**ENGINE POWER LOSS**

The most common cause of engine power loss is mismanagement of the fuel. Therefore, the first step to take after engine power loss is to move the fuel selector valve to the tank not being used. This will often keep the engine running even if there is no apparent reason for the engine to stop on the tank being used.

If changing to another tank does not restore the engine:

1. Check fuel pressure, and turn on electric fuel pump if off.
2. Push mixture control to full "RICH."
3. Check ignition switch. Turn to best operating magneto - left, right, or both.

**MOORINGS**

The Cherokee Arrow should be moved on the ground with the aid of the nose wheel tow bar provided with each plane and secured in the baggage compartment. Tie down ropes may be secured to rings provided under each wing and to the tail skid.



The aileron and stabilator controls should be secured by looping the safety belt through the control wheel and pulling it tight. The rudder is held in position by its connections to the nose wheel steering and normally does not have to be secured. The flaps are locked when in the full up position and should be left retracted.

### WEIGHT AND BALANCE

It is the responsibility of the owner and pilot to determine that the airplane remains within the allowable weight vs. center of gravity envelope while in flight. For weight and balance data see the Airplane Flight Manual and Weight and Balance form supplied with each airplane.

### OPERATING TIPS

The following Operating Tips are of particular value in the operation of the Cherokee Arrow.

1. Learn to trim for take-off so that only a very light back pressure on the wheel is required to lift the airplane off the ground.
2. On take-off, do not retract the gear prematurely. The airplane may settle and make contact with the ground because of lack of flying speed, atmospheric conditions, or rolling terrain.
3. The best speed for take-off is about 65 MPH under normal conditions. Trying to pull the airplane off the ground at too low an airspeed decreases the controllability of the airplane in event of engine failure.
4. In high density areas where high traffic pattern speeds are necessary or when it is advantageous to extend the gear, it is permissible to extend the landing gear at speeds up to 150 MPH.
5. Flaps may be lowered at airspeeds up to 125 MPH. To

reduce flap operating loads, it is desirable to have the airplane at a slower speed before extending the flaps.

6. Before attempting to reset any circuit breaker, allow a two to five minute cooling off period.
7. Always determine position of landing gear by checking the gear position lights.
8. Remember that when the panel lights are on, the gear position lights are very dim.
9. Before starting the engine, check that all radio switches, light switches, and the pitot heat switch are in the off position so as not to create an overloaded condition when the starter is engaged.
10. A high fuel pressure indication on the fuel flow indicator is a possible sign of restricted airbleed nozzles.
11. The overvoltage relay is provided to protect the electronics equipment from a momentary overvoltage condition (approximately 16.5 volts and up), or a catastrophic regulator failure. In the event of a momentary condition, the relay will open and the ammeter will indicate "0" output from the alternator. The relay may be reset by switching the master switch to "OFF" for approximately one minute and then returning the master switch to "ON." If after recycling the master switch the condition persists, the flight may be continued on battery alone by monitoring the voltmeter and reducing battery load to minimum.
12. It should always be kept in mind that the back-up gear extender system is intended to lower the gear during the approach should the pilot forget. However, the pilot should always lower the gear during normal operations by using the gear selector switch on the instrument panel.

**SECTION IV**

**PERFORMANCE CHARTS**

Take-off Distance vs Density Altitude . . . . . 33

Altitude Conversion Chart . . . . . 34

Rate of Climb vs Density Altitude . . . . . 35

True Airspeed vs Density Altitude . . . . . 36

Range vs Density Altitude . . . . . 37

Landing Distance vs Density Altitude . . . . . 38

Power Setting Table . . . . . 39

# PA-28R-180 PIPER CHEROKEE

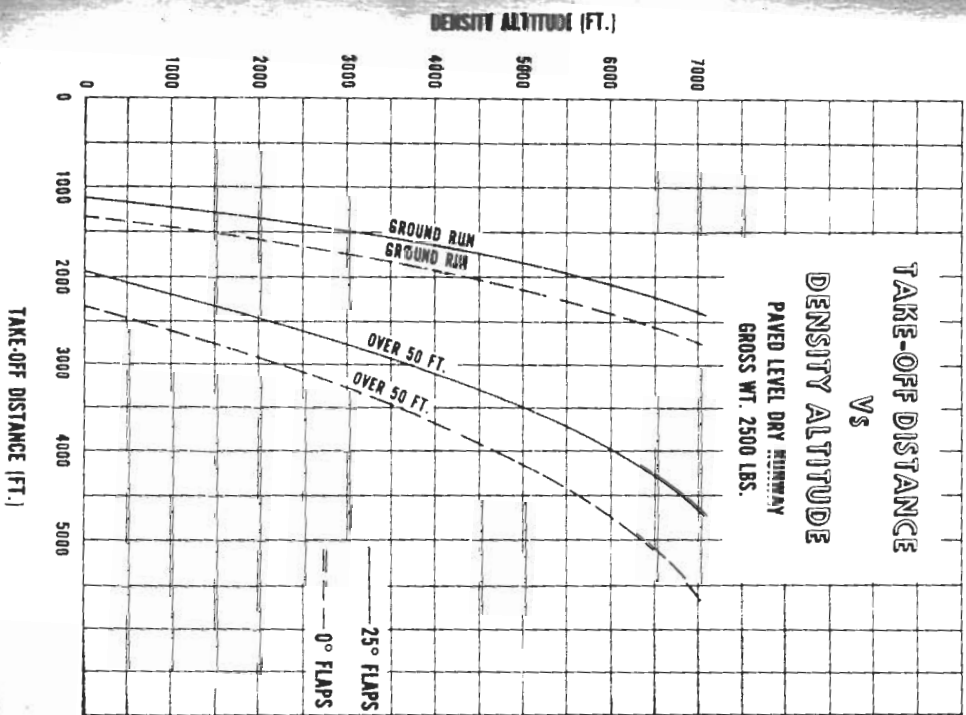

# PA-28R-180 PIPER CHEROKEE

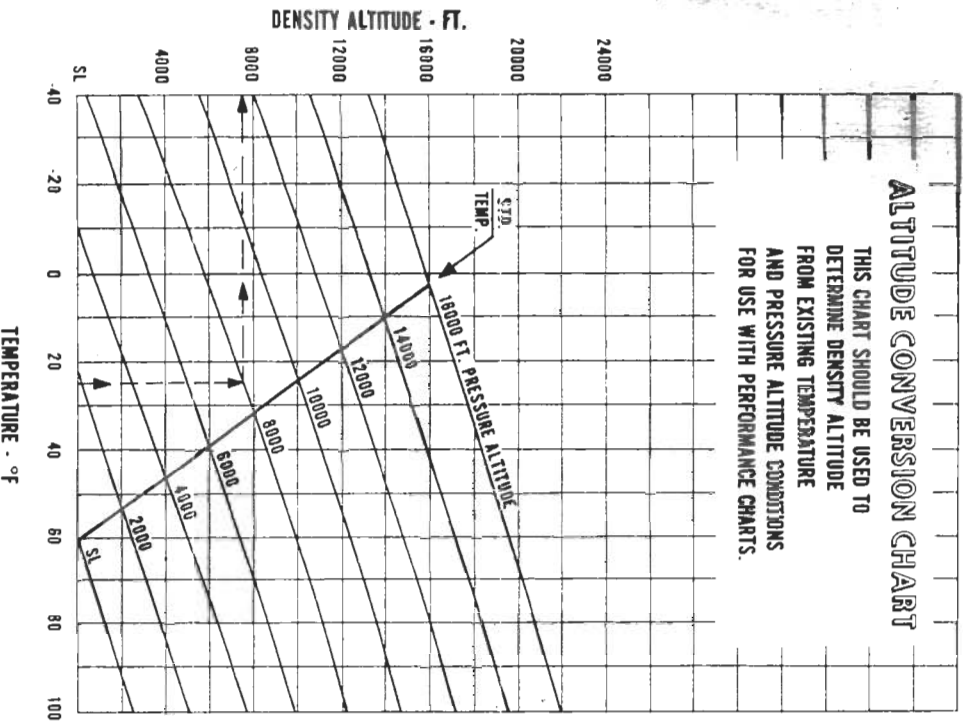

# PA-28R-180 PIPER CHEROKEE

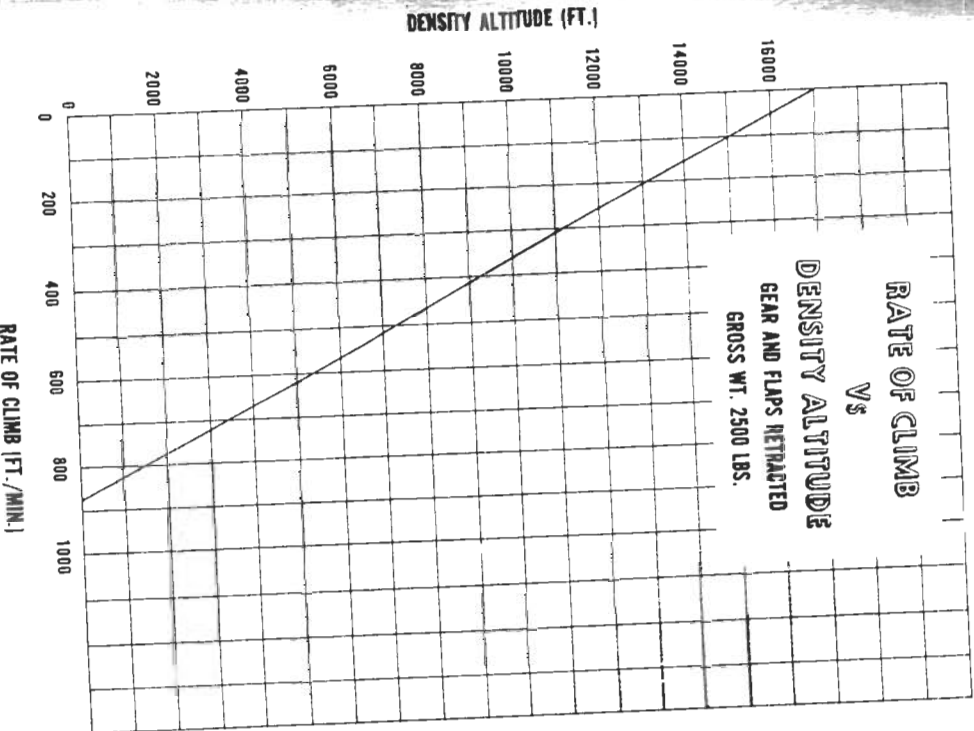

**PA-28R-180  
PIPER CHEROKEE**

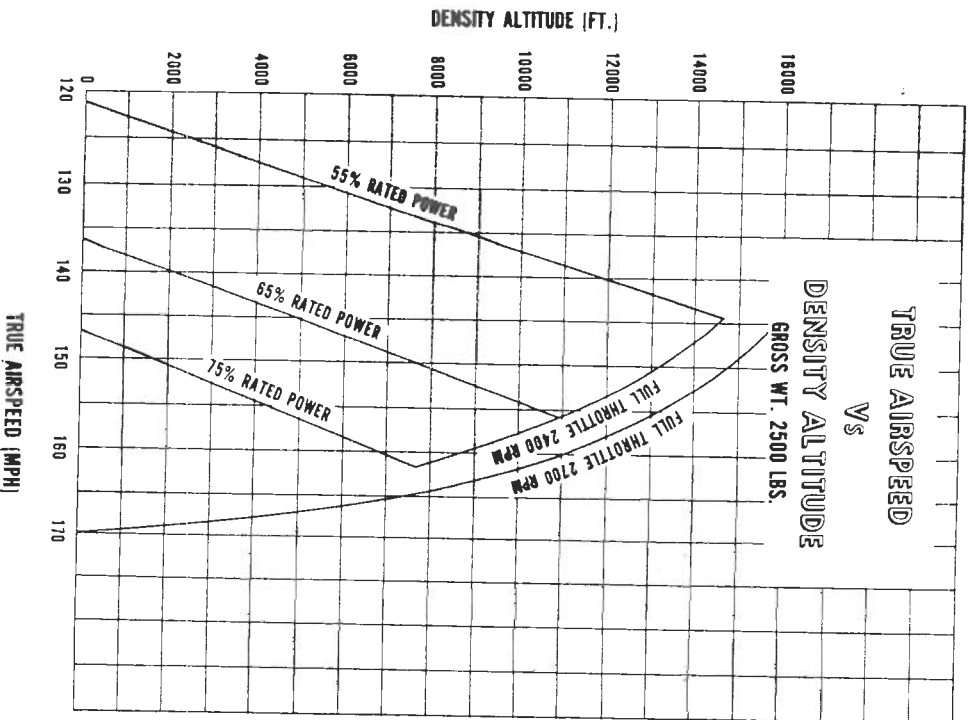

**PA-28R-180  
PIPER CHEROKEE**

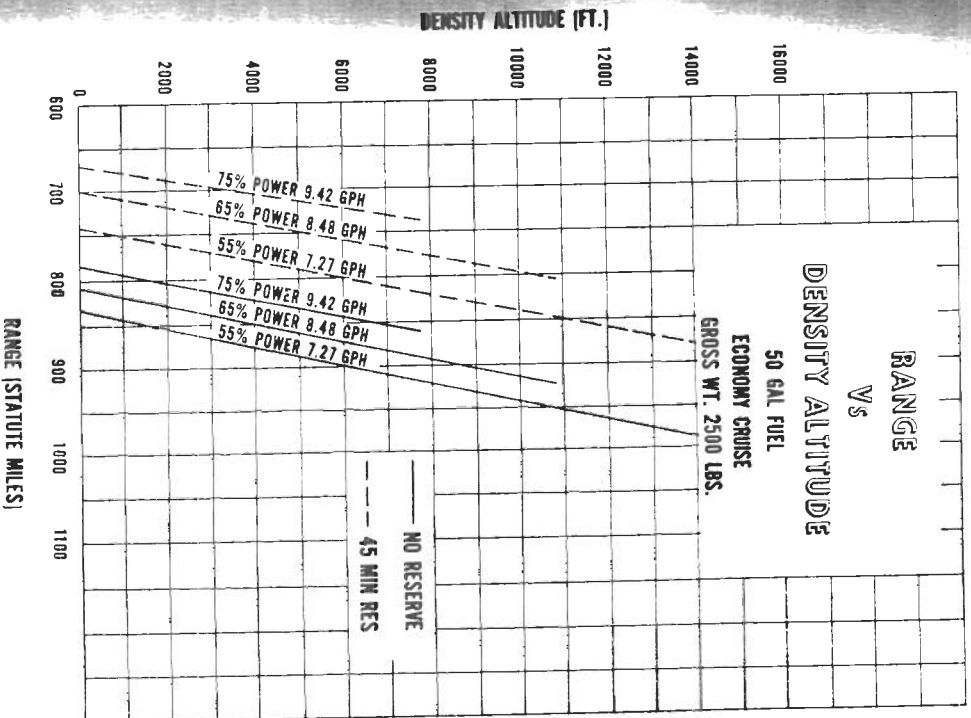

# PA-28R-180 PIPER CHEROKEE

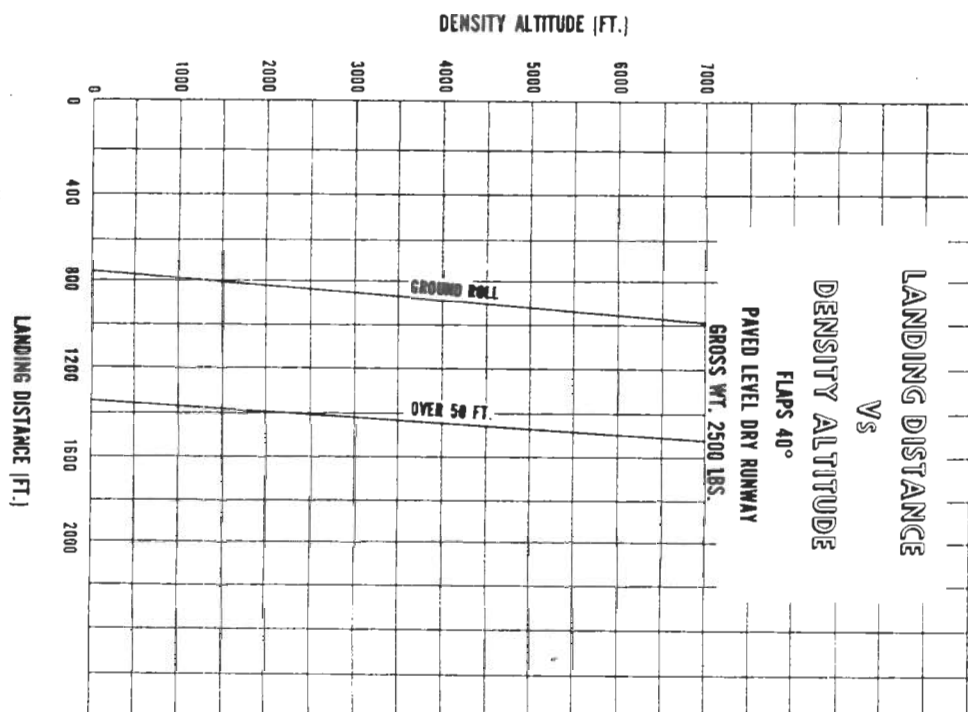

Power Setting Table - Lycoming Model IO-360-B1E Series, 180 HP Engine

Press. Alt Feet	Std. Alt Temp °F	99 HP - 55% Rated RPM AND MAN. PRESS.				117 HP - 65% Rated RPM AND MAN. PRESS.				135 HP - 75% Rated RPM AND MAN. PRESS.			Press. Alt Feet
		2100	2200	2300	2400	2100	2200	2300	2400	2200	2300	2400	
SL	59	21.2	20.7	20.2	19.7	24.0	23.4	22.8	22.2	26.0	25.4	24.7	SL
1,000	55	21.0	20.5	20.0	19.5	23.8	23.2	22.5	22.0	25.8	25.1	24.5	1,000
2,000	52	20.7	20.3	19.7	19.3	23.5	22.9	22.3	21.8	25.5	24.8	24.2	2,000
3,000	48	20.5	20.0	19.5	19.1	23.2	22.7	22.0	21.5	25.3	24.6	24.0	3,000
4,000	45	20.3	19.8	19.3	18.9	23.0	22.5	21.8	21.3	25.1	24.3	23.8	4,000
5,000	41	20.0	19.6	19.1	18.6	22.7	22.2	21.6	21.1	FT	24.1	23.5	5,000
6,000	38	19.8	19.4	18.9	18.4	22.5	22.0	21.3	20.9	--	FT	23.3	6,000
7,000	34	19.6	19.2	18.7	18.2	22.0	21.8	21.1	20.7	--	--	FT	7,000
8,000	31	19.3	18.9	18.4	18.0	FT	21.5	20.9	20.5				8,000
9,000	27	19.1	18.7	18.2	17.8	--	FT	20.6	20.3				9,000
10,000	23	18.9	18.5	18.0	17.6	--	--	FT	20.1				10,000
11,000	19	18.6	18.3	17.8	17.4	--	--	--	FT				11,000
12,000	16	18.4	18.1	17.6	17.2								12,000
13,000	12	FT	17.8	17.4	17.0								13,000
14,000	9	--	FT	17.1	16.8								14,000
15,000	5	--	--	FT	FT								15,000

To maintain constant power, correct manifold pressure approximately 0.17" Hg for each 10° F variation in carburetor air temperature from standard altitude temperature. Add manifold pressure for air temperatures above standard; subtract for temperatures below standard.

SECTION V  
GENERAL MAINTENANCE

Hydraulic System Service . . . . .	40
Landing Gear Service . . . . .	40
Brake Service . . . . .	42
Tire Inflation . . . . .	43
Care of Windshield and Windows . . . . .	43
Battery Service . . . . .	44
Fuel and Oil Requirements . . . . .	44
Fuel System . . . . .	45
Care of Air Filter . . . . .	45
Leveling and Rigging . . . . .	45
Serial Number Plate . . . . .	47

## SECTION V

## GENERAL MAINTENANCE

This section of the Cherokee Arrow Handbook contains information which pertains to minor maintenance of the airplane. For further maintenance assistance refer to the Service Manual for this airplane. Any complex repairs or modification should be accomplished by a Piper Certified Service Center or equivalent.

## HYDRAULIC SYSTEM SERVICE

The fluid level of the hydraulic reservoir should be checked every 50 hours by viewing the fluid level through the filler plug hole in the hydraulic pump. Access to the pump is through the panel at the right rear side of the baggage compartment.

To check fluid level, remove the filler plug located on the forward side of the pump and ascertain that fluid is visible up to the bottom of the filler plug hole. Should fluid be below the hole, loosen the vent screw and add fluid, MIL-H-5606, through the filler hole until full. Reinstall the filler plug and tighten the vent screw.

## LANDING GEAR SERVICE

The main wheels are Cleveland Aircraft Products, Model #40-84, with Cleveland dual disk hydraulic brake assembly, Model #30-41. The main wheel tires are 6.00 x 6, four ply rating, type III with tubes. The nose wheel is a Cleveland Aircraft



## SECTION V

### CHEROKEE "ARROW"

Products, Model #40-77 with a 5.00 x 5, four ply rating, type III tire with tube.

Wheels are removed by taking off the hub caps, cotter pin, axle nut, and the four bolts holding the brake segment in place. Mark tire and wheel for reinstallation then dismount by deflating the tire, removing the three through-bolts from the wheel and separating the wheel halves.

Landing gear oleos on the Cherokee Arrow should be serviced according to the instructions on the units. The main oleos should be extended under normal static load\* until  $2.0 \pm .25$  inches of oleo piston tube is exposed, and the nose gear should show  $2.75 \pm .25$  inches. To add air to the oleo struts, attach a strut pump to the valve assembly near the top of the oleo strut housing and pump the oleo to the desired position. To add oil, jack the aircraft, release the air pressure in the strut, remove the valve core and add oil through this opening with the strut extended. After the strut is full, compress it slowly and fully to allow excess air and oil to escape. With the strut still compressed reinsert the valve stem and pump up the strut as above.

In jacking the aircraft for landing gear or other service, two hydraulic jacks and a tail stand should be used. At least 250 pounds of ballast should be placed on the base of the tail stand before the airplane is jacked up. The hydraulic jacks should be placed under the jack points on the bottom of the wing and the airplane jacked up until the tail skid is at the right height to attach the tail stand. After the tail stand is attached and the ballast added, jacking may be continued until the airplane is at the height desired. There is also a jack point behind the nose gear actuating cylinder.

The steering arms from the rudder pedals to the nose wheel are adjusted at the rudder pedals or at the nose wheel by turning in or out the threaded rod end bearings. Adjustment is normally accomplished at the forward end of the rods and should be done in such a way that the nose wheel is in line with the fore and aft axis of the plane when the rudder pedals and rudder are centered. Alignment of the nose wheel can be checked by pushing

\* Empty weight of airplane plus full fuel and oil.

### CHEROKEE "ARROW"

## SECTION V

the airplane back and forth with the rudder centered to determine that the plane follows a perfectly straight line. The turning arc of the nose wheel is 30 degrees in either direction and is factory adjusted at stops on the bottom of the forging. The turning radius of the nose wheel is 13 feet.

The steering arm stops should be carefully adjusted so that the nose wheel reaches its full travel just after the rudder hits its stops. This guarantees that the rudder will be allowed to move through its full travel.

Incorporated with each gear assembly are micro-switches. The down switches are connected individually to green indicator lights on the instrument panel and close when the gear is locked down. The up switches are in series-parallel and open after each gear is fully up. When this circuit opens, the yellow "gear in transit" light goes out. The micro-switches must be adjusted carefully so that contact is made just as the gear reaches the required position. The gear position lights are dim when panel lights are on.

Located in the control quadrant below the throttle are two micro-switches. These switches activate the warning horn and the red light on the instrument panel under the following conditions:

1. Gear up and power reduced below approximately 14" of manifold pressure.
2. Gear extended (back-up system) but gear selector switch is "UP," except at full throttle.
3. Gear selector switch in "UP" position while on the ground.

On the left oleo is a micro-switch which prevents the gear from retracting if the oleo is compressed, i.e. on the ground.

### BRAKE SERVICE

The brake system is filled with MIL-H-5606 (Petroleum base) hydraulic brake fluid. This should be checked at every 40 hour inspection and replenished when necessary by filling the brake

## SECTION V

### CHEROKEE "ARROW"

reservoir on the upper left front side of the firewall to the indicated level. If the system as a whole has to be refilled with fluid it should be done from the brake end of the system by filling with fluid under pressure. This will eliminate air from the system as it is being filled.

No adjustment of brake clearances is necessary on the Cherokee Arrow brakes. If after extended service the brake blocks become worn excessively, they are easily replaced with new segments.

### TIRE INFLATION

For maximum service from the tires on the Cherokee Arrow, keep the tires inflated to the proper pressure of 27 pounds per square inch for the main wheels and 30 pounds per square inch for the nose wheel. Interchange the tires on the main wheels if necessary to produce even wear. All wheels and tires are balanced before original installation, and the relationship of the tire, tube, and wheel should be maintained if at all possible. Unbalanced wheels can cause extreme vibration on take-off. In the installation of new components it may be necessary to rebalance the wheel with the tire mounted.

### CARE OF WINDSHIELD AND WINDOWS

A certain amount of care is needed to keep the plexiglas windows clean and unmarred. The following procedure is recommended:

1. Flush with clean water and dislodge excess dirt, mud, etc. with your hand.
2. Wash with mild soap and water or Piper Plastic Cleaner. Use a soft cloth or sponge. Do not rub.
3. Remove oil, grease or sealing compounds with a soft cloth and kerosene.

### CHEROKEE "ARROW"

## SECTION V

4. After cleaning, apply a thin coat of hard polishing wax. Rub lightly with a soft cloth.

5. A severe scratch or mar may be removed by using jeweler's rouge to rub out the scratch, smoothing, and then applying wax.

### BATTERY SERVICE

Access for service or inspection of the battery is obtained through the removal of the panel at the right rear side of the baggage compartment. The stainless steel box has a plastic drain tube which is normally closed off with a cap. Check the battery box at 50-hour or 30-day intervals, whichever occur first. The battery should be checked for proper fluid level, but must not be filled above the baffle plates. Use only water - no acid. A hydrometer check should be performed to determine the percent of charge present in the battery.

If the battery is not up to charge, recharge starting at a 4 ampere rate and finishing with a 2 ampere rate. Quick charges are not recommended.

### FUEL AND OIL REQUIREMENTS

Aviation Grade 100/130 Octane (minimum) fuel must be used in the Cherokee Arrow, since the use of lower grades can cause serious engine damage in a very short period of time and the engine warranty is invalidated by such use.

The oil capacity of the Lycoming IO-360-B1E series engine is 8 quarts, and the minimum safe quantity is 2 quarts. It is recommended that the oil and oil filter be changed every 50 hours, or sooner under unfavorable conditions. The following grades are recommended for the specified temperatures:

## SECTION V

## CHEROKEE "ARROW"

Temperatures above 60° F	S.A.E. 50
Temperatures between 30° F and 90° F	S.A.E. 40
Temperatures between 0° F and 70° F	S.A.E. 30
Temperatures below 10° F	S.A.E. 20

## FUEL SYSTEM

The fuel screens in the strainer and the injector will require cleaning every 50 hour inspection. The screen in the injector is located in the housing where the fuel inlet line connects to the injector. The fuel strainer, located ahead of the firewall, is accessible for cleaning by removal of the lower cowl. When the strainers are reassembled after cleaning, a small amount of grease applied to the gasket will facilitate assembly.

## CARE OF AIR FILTER

The injector air filter must be cleaned at least once every fifty hours. Under extremely adverse conditions of operation it may be necessary to clean the filter daily. Extra filters are inexpensive and a spare should be kept on hand and used as a rapid replacement.

The filter manufacturer recommends that the filter be tapped gently to remove dirt particles. Do not blow out with compressed air.

## LEVELING AND RIGGING

Leveling the Cherokee Arrow for purposes of weighing or rigging is accomplished as follows:

1. Partially withdraw two machine screws located immediately below the left front side window. These screws are

## CHEROKEE "ARROW"

## SECTION V

leveling points, and the airplane is longitudinally level when a level placed on the heads of these screws indicates level.

2. To put the airplane in a longitudinally level position on scales, first block the main gear oleos in the fully extended position, then deflate the nose wheel tire until the proper attitude is obtained. For rigging only, the airplane may be placed on jacks for leveling.

3. To level the airplane laterally, place a level across the baggage compartment floor along the rear bulkhead.

Rigging: Although the fixed flight surfaces on the Cherokee Arrow cannot be adjusted for rigging purposes, it may be necessary upon occasion to check the position of these surfaces. The movable surfaces all have adjustable stops, as well as adjustable turnbuckles on the cables or push-pull tubes, so that their range of travel can be altered. The positions and angular travels of the various surfaces are as follows:

1. Wings: 7° dihedral, 2° washout.
2. Stabilator Travel: 18° ±1° up, 2° ±1° down.
3. Fin should be vertical, and in line with center of fuselage.
4. Ailerons Travel: 30° ±2° up, 15° ±2° down.
5. Flaps Travel: 0° up, 10°, 25°, 40° ± 2° down.
6. Rudder Travel: 27° from center ±2° left and right.
7. Stabilator Tab Travel: 3° ±1° up, 12° ±1° down.

Cable tensions for the various controls are as follows:

Rudder: 40 lbs. ±5 lbs.	Stabilator: 40 lbs. ±5 lbs.
Ailerons: 40 lbs. ±5 lbs.	Stabilator Trim: 10 lbs. ±1 lb.
Flaps: 10 lbs. ±1 lb.	

For extreme cases of wing heaviness, the flap on the wing heavy side may be adjusted down from the zero position **as desired.**

SECTION V

CHEROKEE "ARROW"

SERIAL NUMBER PLATE

The serial number plate is located near the stabilator on the left side of the airplane. Refer to this number for service or warranty matters.

CHEROKEE "ARROW"

SECTION V

NOTES

SECTION V

CHEROKEE "ARROW"

NOTES

CHEROKEE "ARR

SECTION V

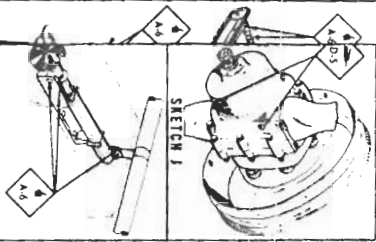

SKETCH I

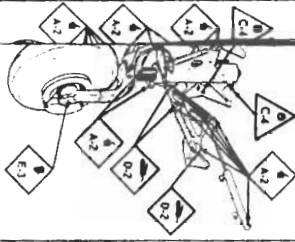

SKETCH II

NOTES

NOTE - LUBRICATE TRACK ROLLERS WITH TYPE OF LUBRICANT. "A" LUBRICANT IS RECOMMENDED. LUBRICATE SELECTOR VALVE AS SERVICE LETTER NO. 351. INSTRUCTIONS NO. 1312 FOR USE OF

CAUTIONS

DO NOT USE CASTOR OIL OR OTHER LUBRICANTS WITH RUBBER PARTS.

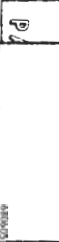

SKETCH III



# INDEX

## SECTION I

	Page
Specifications: . . . . .	1
Performance . . . . .	1
Weights . . . . .	2
Power Plant . . . . .	2
Fuel and Oil . . . . .	2
Baggage . . . . .	2
Dimensions . . . . .	3
Landing Gear . . . . .	3

## SECTION II

Design Information: . . . . .	5
Engine and Propeller . . . . .	5
Induction System . . . . .	5
Structures . . . . .	6
Landing Gear . . . . .	7
Control Systems . . . . .	11
Fuel System . . . . .	11
Electrical System . . . . .	12
Heating and Ventilating System . . . . .	16
Cabin Features . . . . .	16

## SECTION III

Operating Instructions: . . . . .	20
Preflight . . . . .	20
Starting Engine . . . . .	21
Warm-Up and Ground Check . . . . .	23
Take-Off . . . . .	24
Climb . . . . .	25
Stalls . . . . .	25

INDEX (cont)

SECTION III (cont)

Cruising . . . . .	Page	26
Approach and Landing . . . . .	27	
Stopping Engine . . . . .	28	
Emergency Gear Procedures . . . . .	29	
Engine Power Loss . . . . .	30	
Moorings . . . . .	30	
Weight and Balance . . . . .	31	
Operating Tips . . . . .	31	

INDEX (cont)

SECTION V (cont)

Care of Air Filter . . . . .	Page	45
Leveling and Rigging . . . . .	45	
Serial Number Plate . . . . .	47	

SECTION IV

Performance Charts: . . . . .	33
Take-off Distance vs Density Altitude . . . . .	33
Altitude Conversion Chart . . . . .	34
Rate of Climb vs Density Altitude. . . . .	35
True Airspeed vs Density Altitude . . . . .	36
Range vs Density Altitude . . . . .	37
Landing Distance vs Density Altitude . . . . .	38
Power Setting Table . . . . .	39

SECTION V

General Maintenance: . . . . .	40
Hydraulic System Service . . . . .	40
Landing Gear Service . . . . .	40
Brake Service . . . . .	42
Tire Inflation . . . . .	43
Care of Windshield and Windows . . . . .	43
Battery Service . . . . .	44
Fuel and Oil Requirements . . . . .	44
Fuel System: . . . . .	45